

1

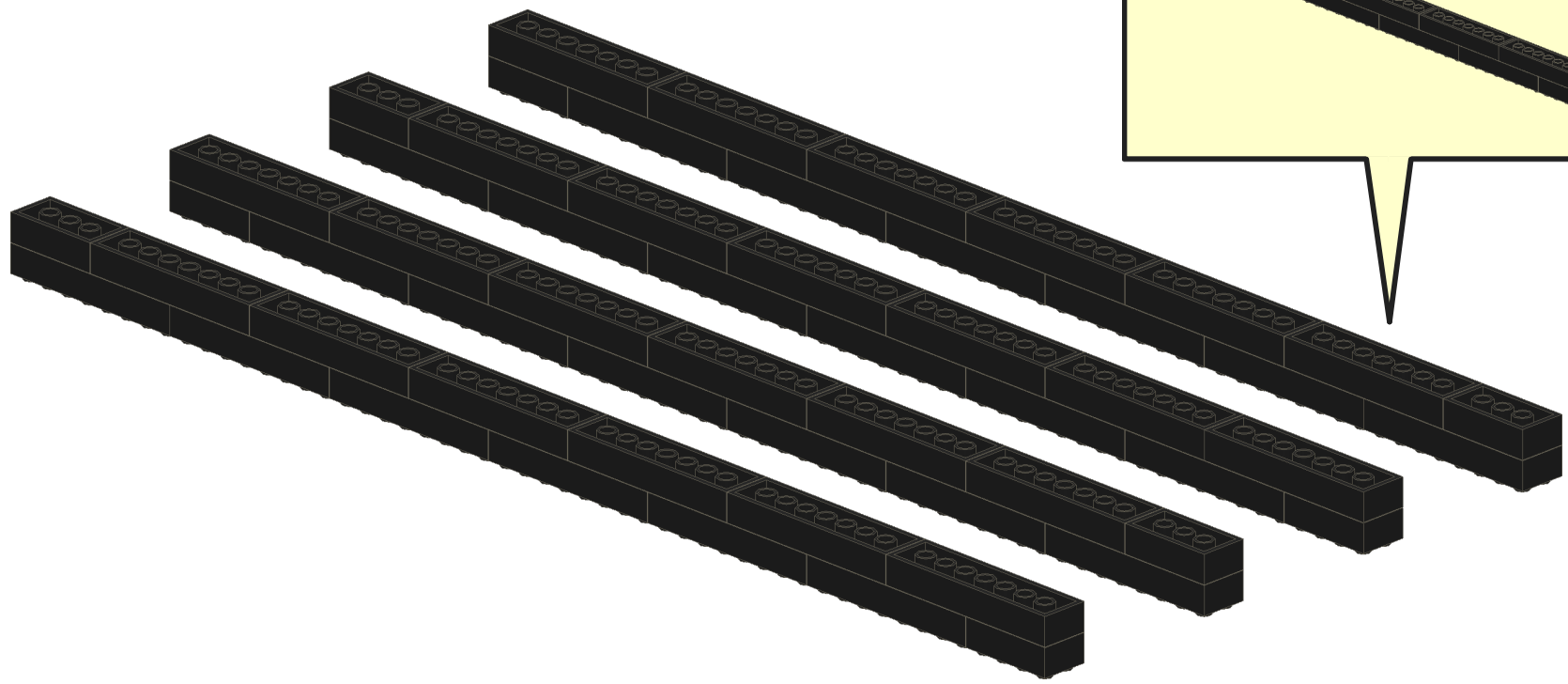

1

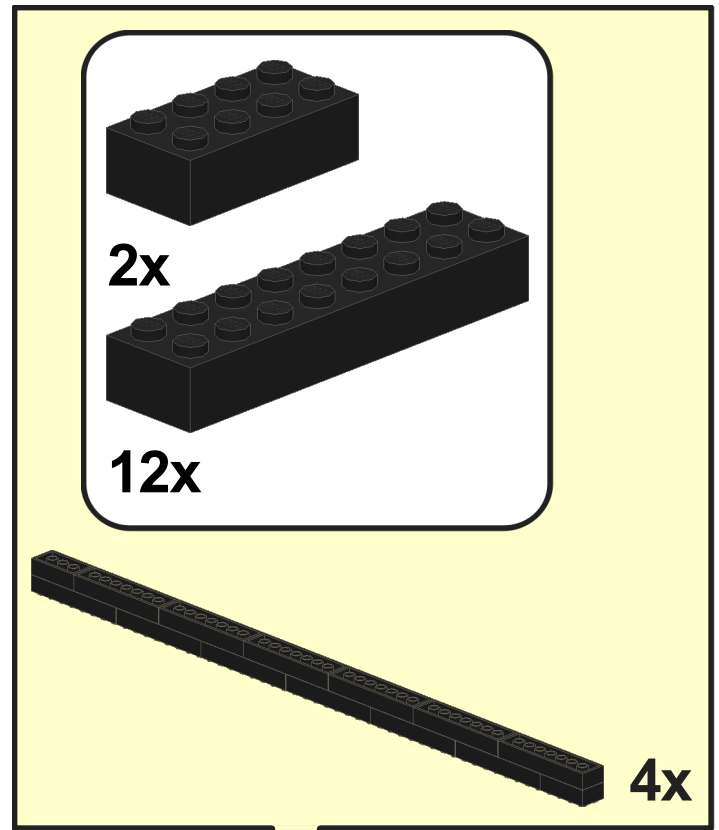
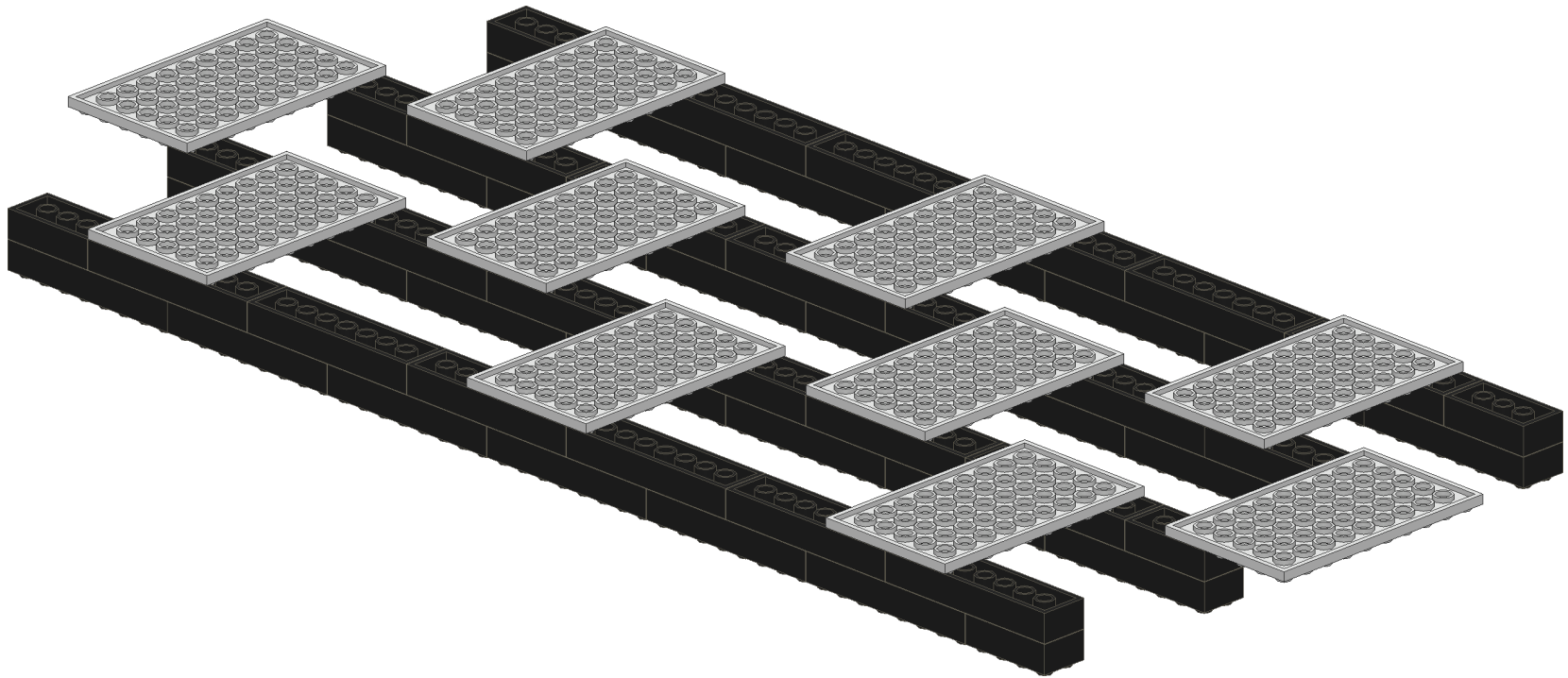
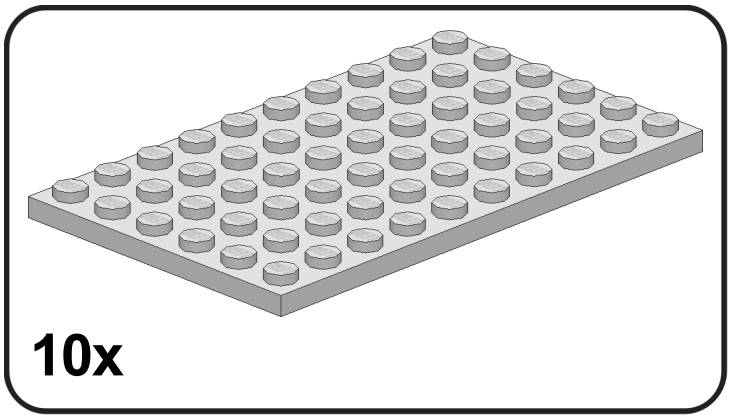

3

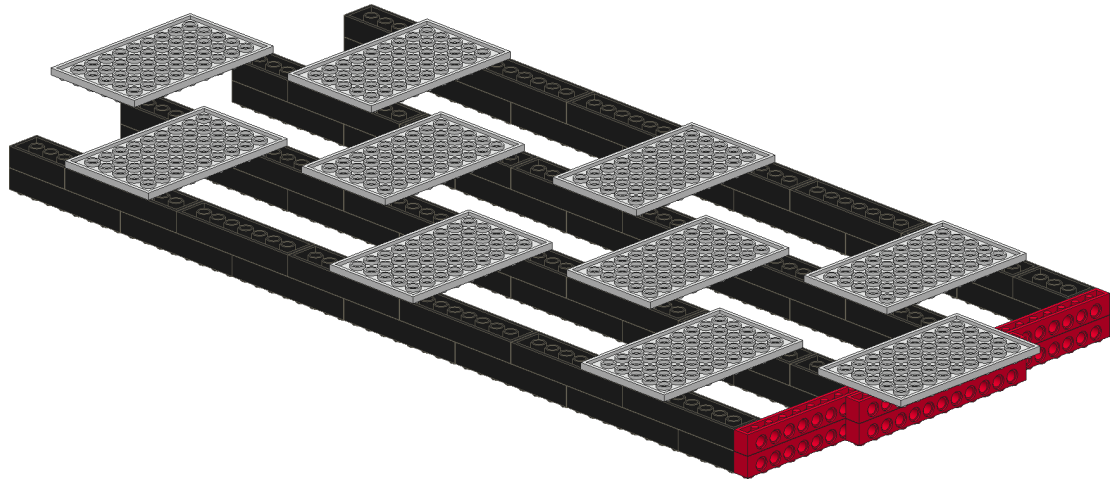
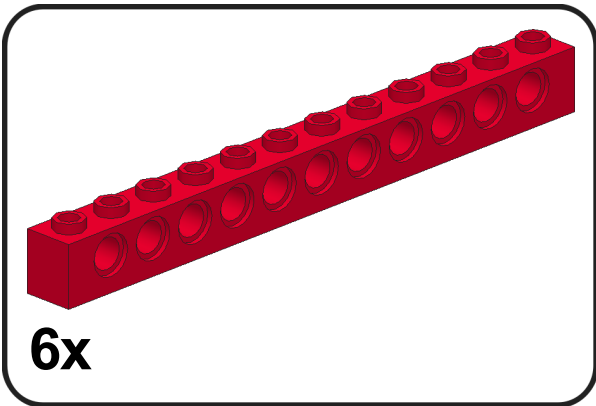

4

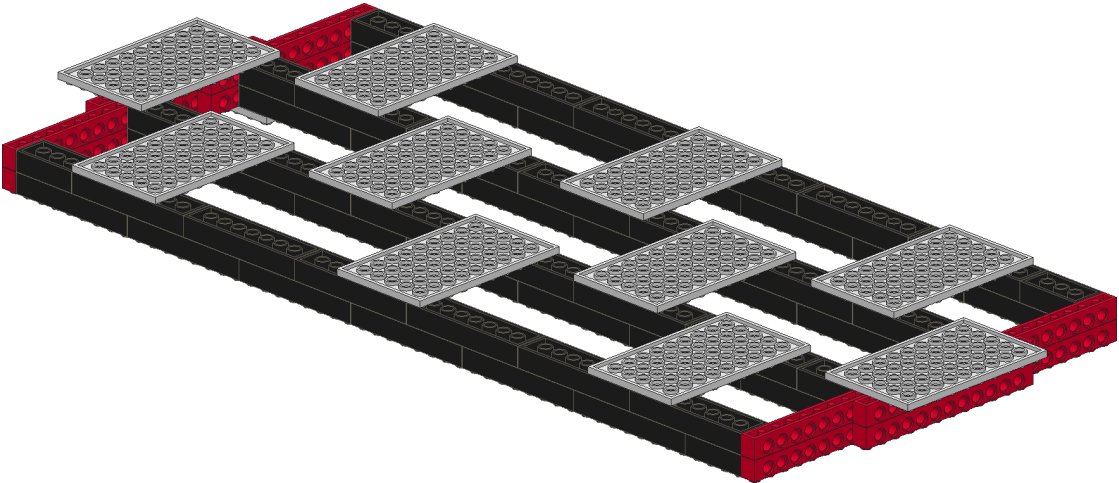
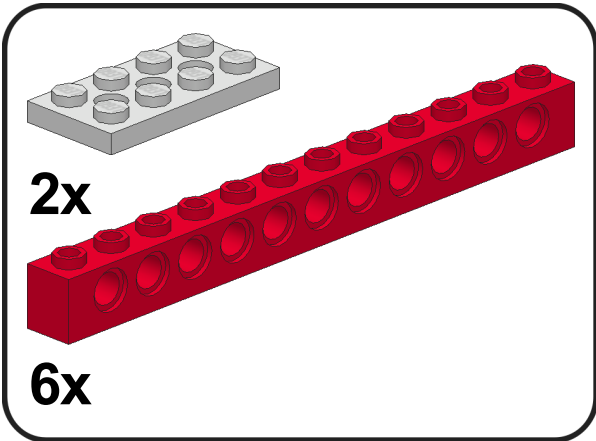

5

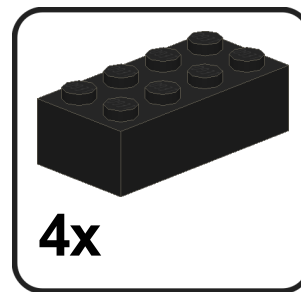
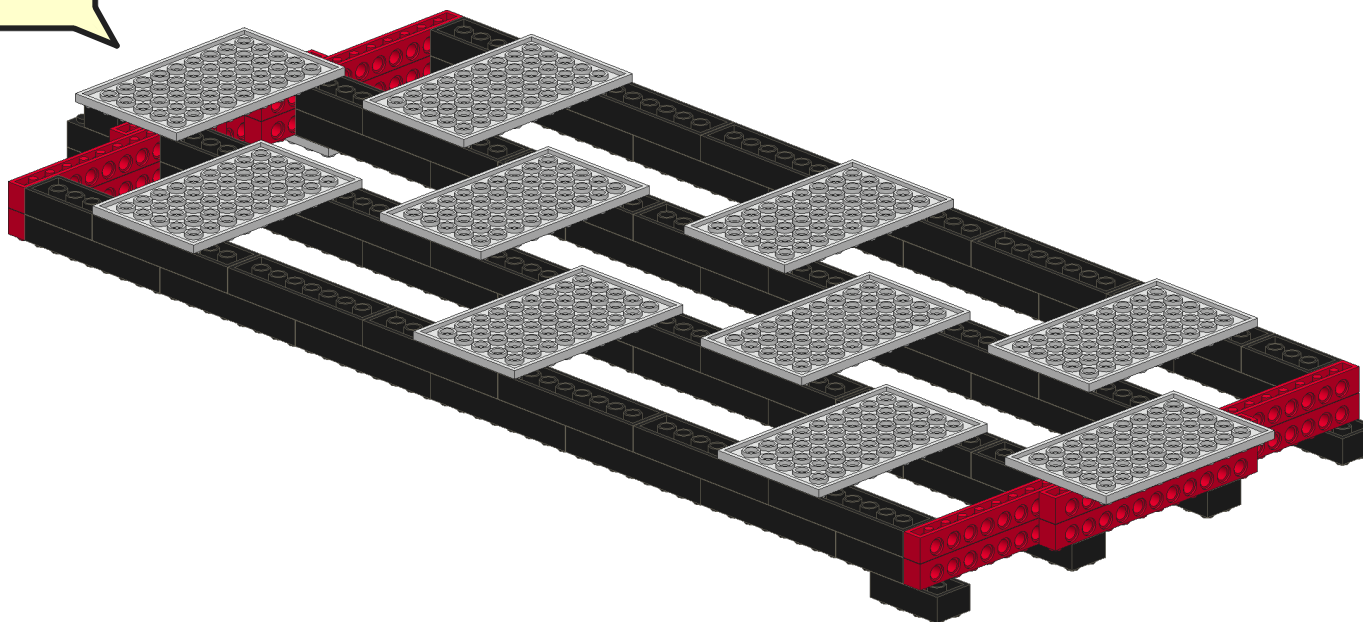
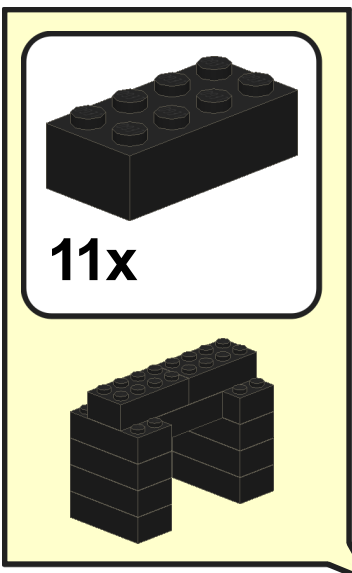

1

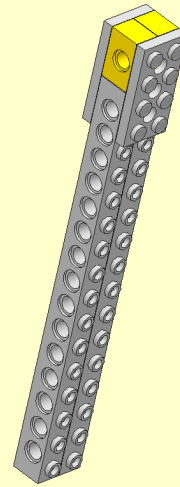
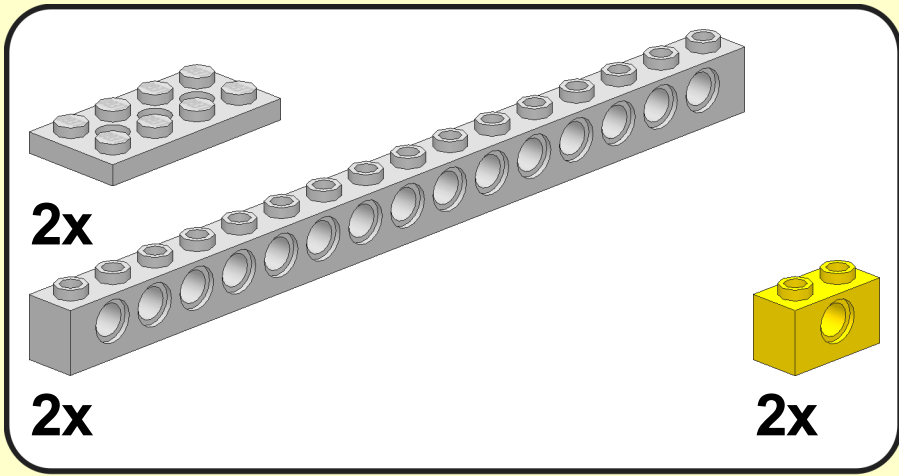

2

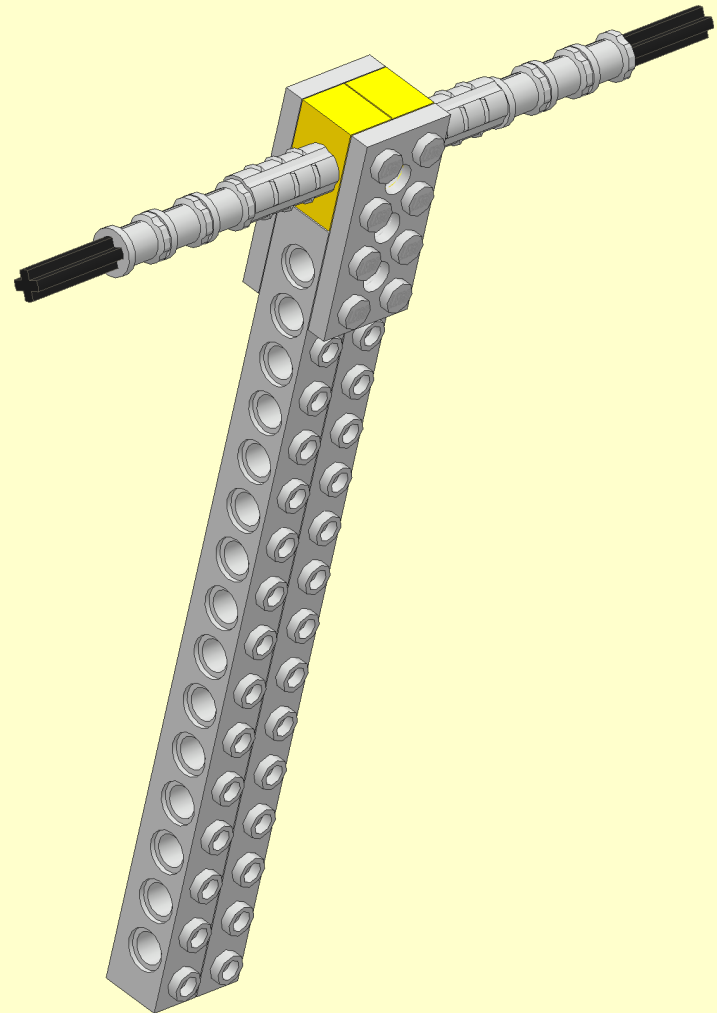
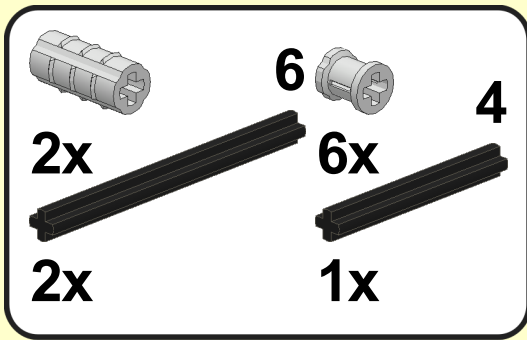

3

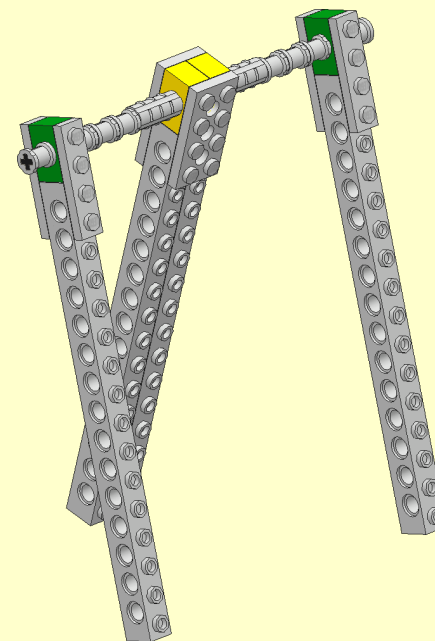
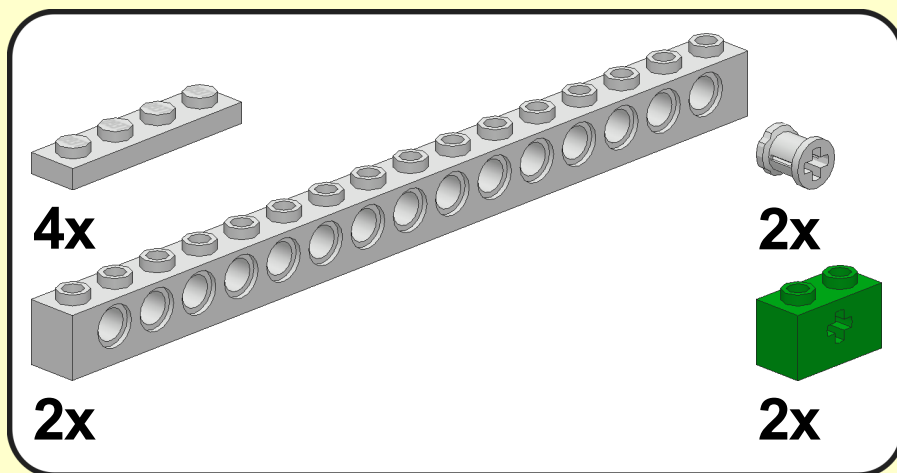

4

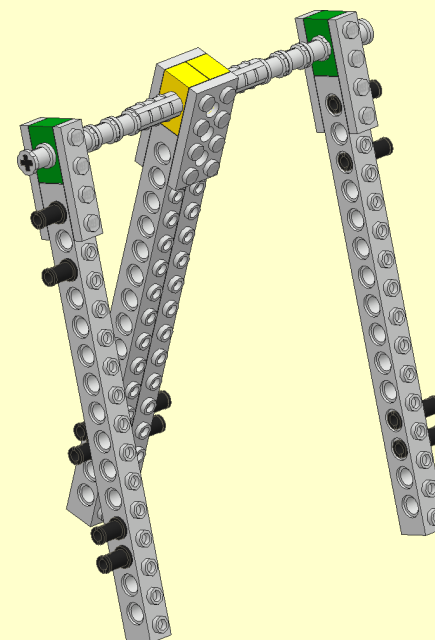

5



10x



4x

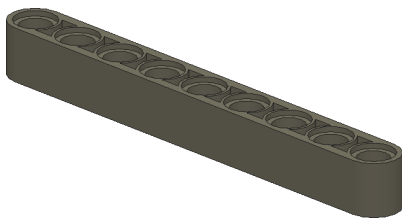

4x

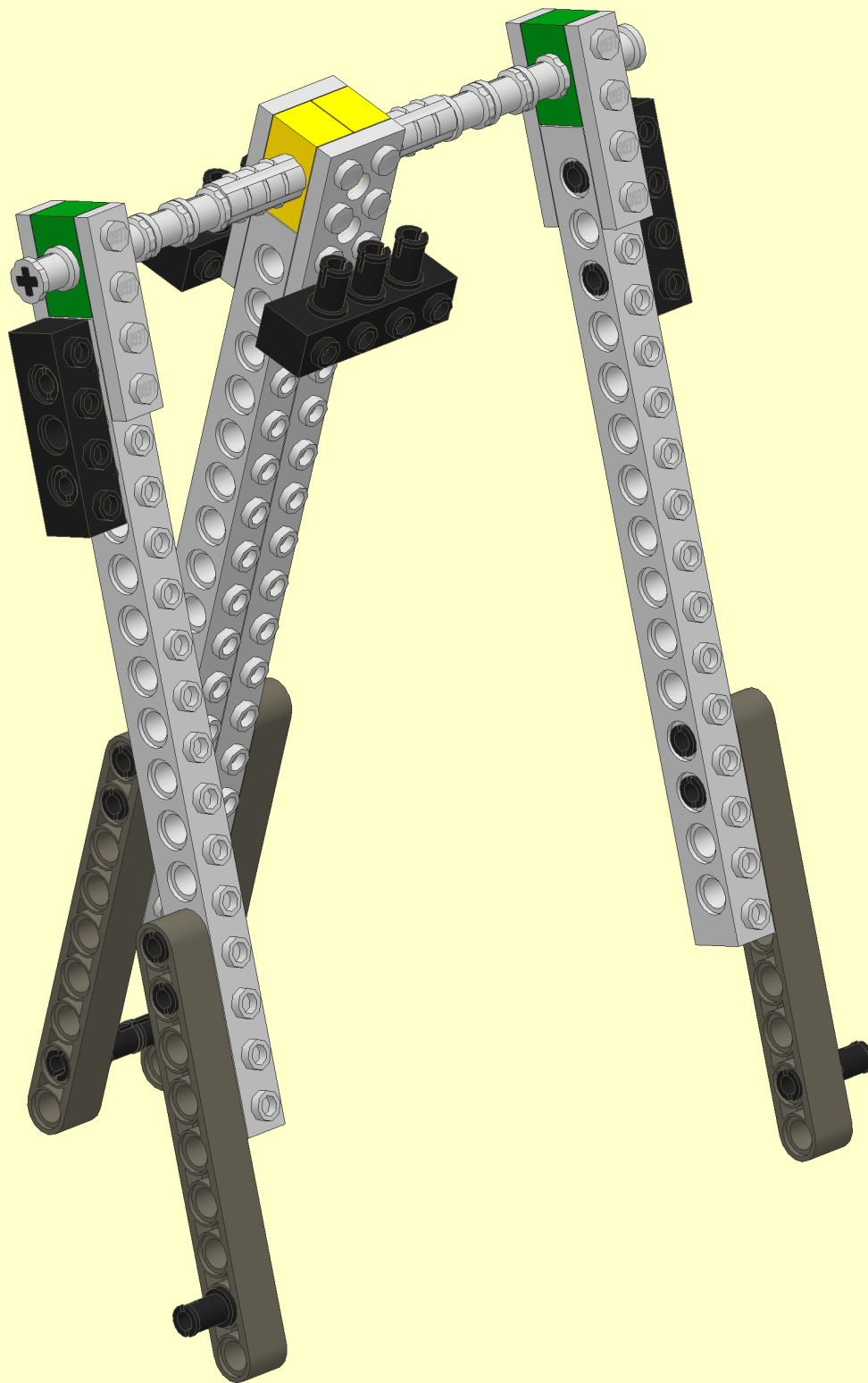



6

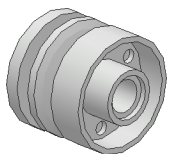

3x

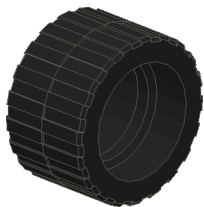

3x

